

Entro[®] V DV65

(242 m³/h)

KIT SUITABLE FOR DWELLING FLOOR AREA UP TO 116 m²





MORE THAN 60 YEARS OF EXPERIENCE

Founded in 1955, Airflow has grown from one man's expertise in fan design and air flow measurement into a thriving international group. Renowned for its innovative approach to new product development and air movement techniques, Airflow can offer you a variety of ventilation solutions to suit your needs.

With our headquarters in High Wycombe, Airflow has subsidiaries in Germany and the Czech Republic and has global distributors from Norway to New Zealand.

Understanding the requirements of our customer enables Airflow's knowledgeable and committed staff to continually develop new and innovative products that raise standards and provide long term, reliable ventilation solutions.



UNITED KINGDOM

High Wycombe (Head Office)

Our founder started the business in 1955, just one mile from the current site, which has been Airflow's headquarters since 1960, co-ordinating our global activities.



GERMANY

Airflow has been serving ventilation products and air measurement devices to the German and European markets for over 50 years. Operating near Cologne, Airflow Germany has their own customer service, sales and technical sales teams.



CZECH REPUBLIC

Founded in Prague over 20 years ago, the Airflow Czech Republic team offer sales and servicing of ventilation products for the Eastern European market.



COMPLETE VENTILATION SYSTEM FROM AIRFLOW, ENTRO-V RANGE



A range of SAP PCDB (Product Characteristics Data Base) listed Mechanical Ventilation with Heat Recovery units for residential applications. These top or side entry units are made from galvanised steel, white powder-coated casing with 20 mm EPP insulation that provides significant insulation, a great level of air tightness, thermal efficiency, and sound absorption.

Complete with 100% summer bypass and a number of optional accessories, Entro-V offers the installer a huge range of installation options to suit their ventilation needs.

Entro[®]V DV65



The Entro-V ventilation units with heat recovery are available for a large variety of building sizes. The smallest unit size in the range, Entro-V DV65, can supply up to 242 m³/h (67.2 l/s) and can be installed in vertical mounting positions, on the wall or on the floor. Hanging brackets, screws and feet are supplied with the unit. Also, the unit has interchangeability of spigots position from top to the sides.

In addition to high quality individual ventilation components, an overall integrated concept is essential to a well-functioning ventilation system. Airflow offers the ideal ventilation system solutions and guarantees easy design, safe installations, and maximum efficiency.



WELCOME TO YOUR NEW FUTURE HOME

FITTED WITH AN AIRFLOW VENTILATION SYSTEM WITH HEAT RECOVERY, YOU WILL EXPERIENCE A HEALTHY, FEEL-GOOD AMBIANCE AT ALL TIMES.

An Airflow MVHR system can provide the required minimum air exchange for your home, regardless of your house size this unit can provide the air needed, creating a pleasant room temperature and draught-free, clean air at all times.

Thanks to the integrated filters and the well-thought-through hygiene concept, a healthy atmosphere is created for the whole family to feel comfortable and even those suffering from allergies can breathe freely. The windows can stay shut, meaning pollen, dust, and road noise stay outside.

The continuously running ventilation system reduces moisture which means effective mould and mildew prevention. This protects the building fabric and therefore the value of your property in the long term. In addition, the heat recovery system reduces your overall energy and heating bill costs – meaning you save and actively contribute to the protection of the environment.



To work out the ideal Entro-V ventilation unit required for this example dwelling size, we need to consider the number, type, and size of habitable and wet rooms and their airflow rates, as specified by the Approved Document Part F of the Building Regulations.

The bill of materials from the ventilation unit to the air distribution products required for this example designed ventilation system can be seen on the following pages.

| Room description | Floor | Floor space [m ²] | Room volume [m ³] | Extract air [m ³ /h] | Supply air [m ³ /h] | Extract air terminals | Air volume per extract terminal [m ³ /h] | No. of duct(s) per extract terminal | Supply air terminals | Air volume per supply air terminal [m ³ /h] | No. of duct(s) per supply air terminal |
|------------------------|--------------|-------------------------------|-------------------------------|---------------------------------|--------------------------------|-----------------------|---|-------------------------------------|----------------------|--|--|
| Kitchen | Ground Floor | 7.9 | 18.86 | 48 | - | 1 | Terminal 1: 48 | Duct(s) 1: 2 | - | - | - |
| Living / Dining | Ground Floor | 20.5 | 49.3 | - | 48 | - | - | - | 1 | Terminal 1: 48 | Duct(s) 1: 2 |
| Hall / Cupboard | Ground Floor | 8.8 | 21.19 | - | - | - | - | - | - | - | - |
| W.C. | Ground Floor | 2.2 | 5.21 | 25 | - | 1 | Terminal 1: 25 | Duct(s) 1: 1 | - | - | - |
| Bathroom | Ground Floor | 4.2 | 10.08 | 25 | - | 1 | Terminal 1: 25 | Duct(s) 1: 1 | - | - | - |
| Bed 1 | First Floor | 13.4 | 32.23 | - | 25 | - | - | - | 1 | Terminal 1: 25 | Duct(s) 1: 1 |
| Hall, Cupboard | First Floor | 7.7 | 18.41 | - | - | - | - | - | - | - | - |
| Bed 2 | First Floor | 13.5 | 32.33 | - | 25 | - | - | - | 1 | Terminal 1: 25 | Duct(s) 1: 1 |
| Total: | | 78.2 | 187.61 | 98 | 98 | 3 | 98 | 4 | 3 | 98 | 4 |

Minimum ventilation rate*: 84 m³/h
 Maximum ventilation rate*: 98 m³/h
 Recommended ventilation rate: 91 m³/h @ medium fan speed
 Calculated air exchange rate: 0.49
 * according to Building Regulations Part F, 2022

Manually adjusted ventilation rates:
 Total adjusted extract air: 98 m³/h @ medium fan speed
 Total adjusted supply air: 98 m³/h @ medium fan speed
 Air exchange rate: 0.52

The table above provides you with the following information:

1. How many terminals must be installed for the particular room.
2. Extract or supply air terminals identification.
3. How many ducts should be installed and connected to the respective terminal.
4. Which air volume should flow through the particular terminal when the ventilation system is running at medium fan speed.



Entro[®]V DV65

Mechanical Ventilation with Heat Recovery

AIR DISTRIBUTION CHART

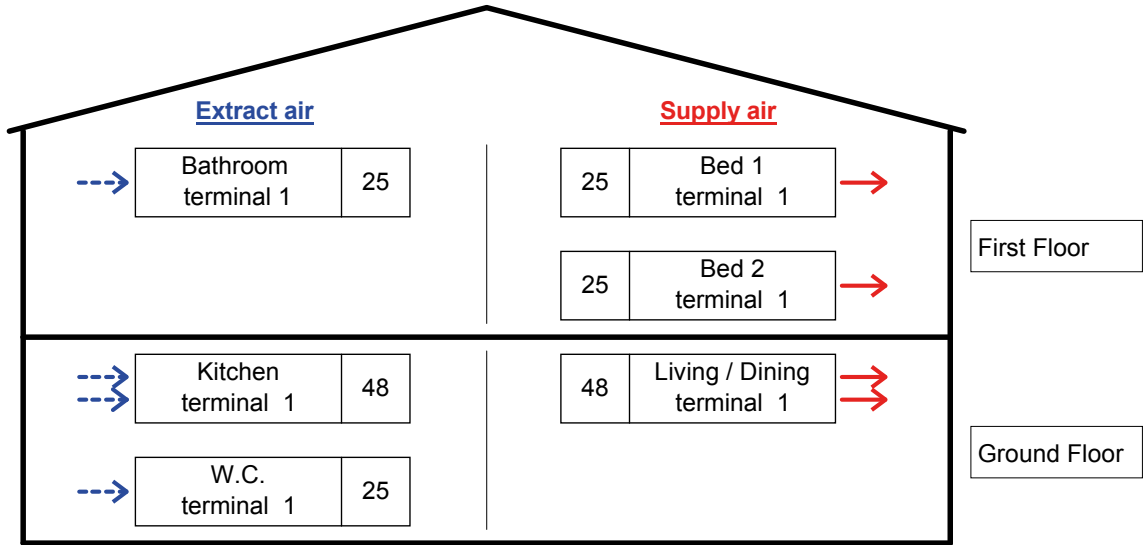

Important: Maximum duct length from Plenum box to Air terminal: 15 m

Key:

---> blue = extract air

---> red = supply air

Number of arrows = number of ducts per terminal

Value = air volume m³/h

DUCT WORK PLAN

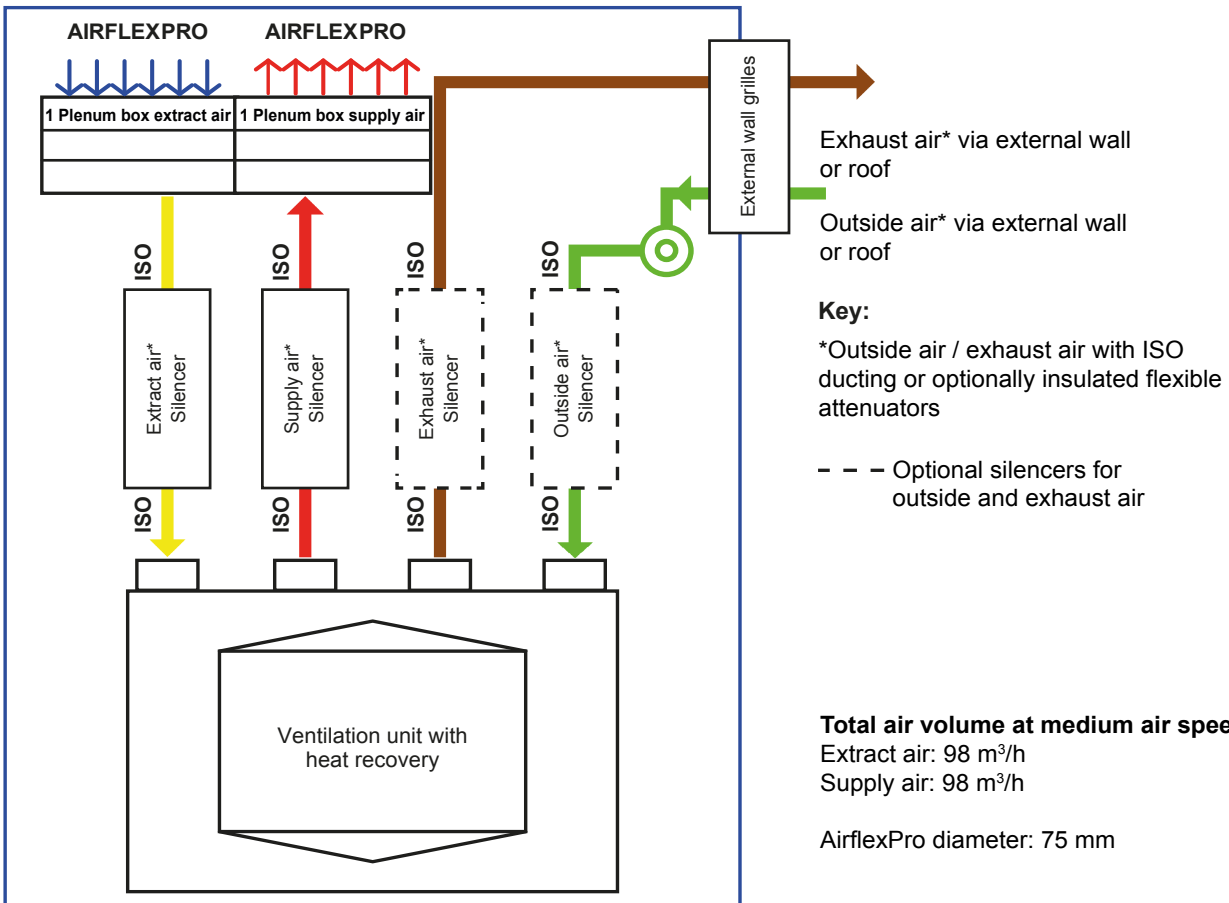

EXAMPLE BUILDING SPECIFICATION AND FLOOR PLANS

Type: Semi-detached house

Living space: 78 m²

Levels: 2







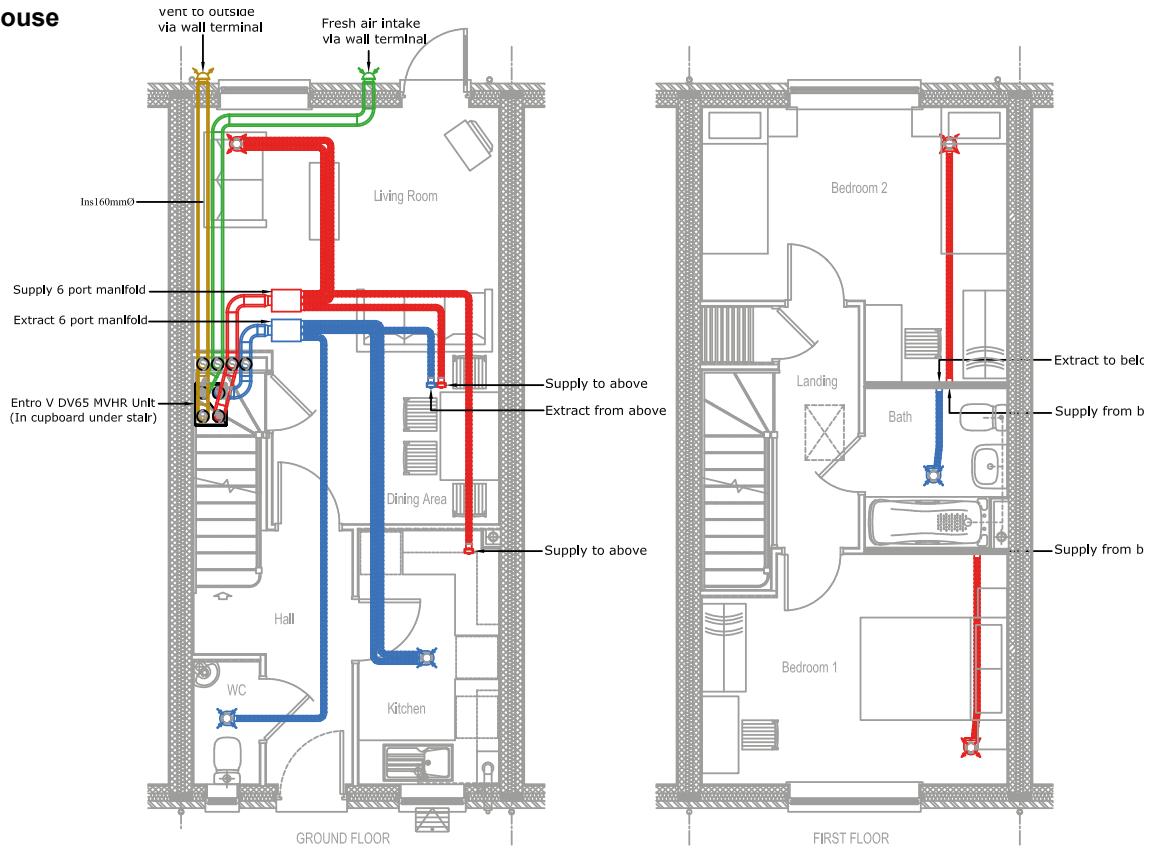

Bedrooms: 2

Habitable rooms: 3

Wet rooms: 3

Note: blue and red is for illustration purposes only.



-  Heat Recovery Unit
-  AirflexPro for fresh supply air
-  AirflexPro for stale extract air
-  Extract valve in ceiling
-  Supply valve in ceiling
-  Vent to outside via wall
-  Fresh air intake via wall
-  Distribution Box
-  Distribution Box

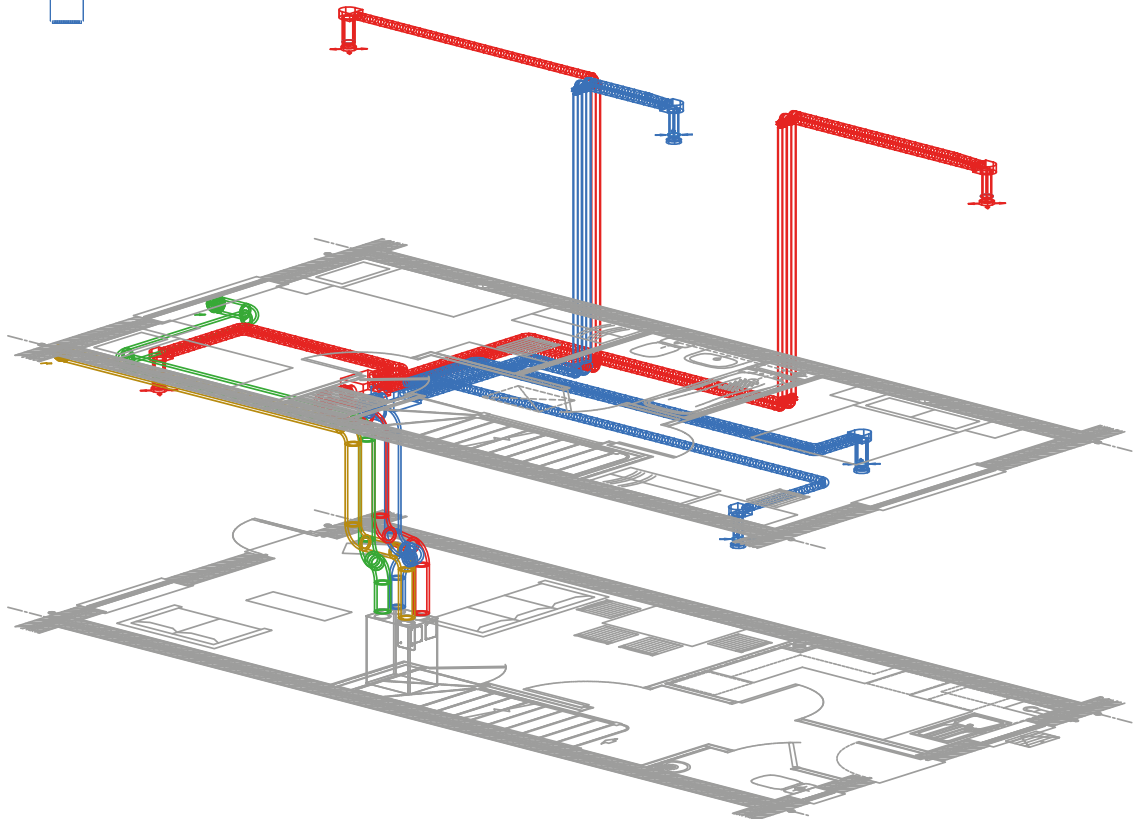

Entro V DV65

Mechanical Ventilation with Heat Recovery



A+

Based on average climate with a local demand control

KEY FEATURES

- 242 m³/h (67.2 l/s) maximum air flow rate @100Pa
- Domestic and residential heat recovery ventilation
- Thermal efficiency capabilities of up to 85%
- 2x ISO ePM Coarse 55% (G4) filters as standard with an extra supply air filter location for an optional ISO ePM1 60% (F7) - ISO 16890 compliant
- Compact design
- Suitable for vertical mounting on the wall or floor (accessories included as standard)
- Easy filter change with no tools needed
- Choice of spigot locations (top or side entry or combination).
- Suitable for left and right hand configurations
- SAP eligible
- 2 year warranty+

Duplexvent DV65 Entro-V

The DV65 Entro-V is a compact and efficient top entry or side entry (or combination) MVHR unit, capable of recovering over 85% of the wasted heat.

The unit is made from galvanised steel, white powder coated casing with 20 mm EPP insulation which provides a great level of air tightness, thermal efficiency and sound absorption. DV65 Entro-V has low energy EC fans with backward curved impellers that minimise the unit's energy consumption with a quiet operation and low specific fan power, achieving an 'A+' energy efficiency.

The unit has an easy to clean and maintain plastic counterflow heat exchanger which prevents the air streams from mixing. In addition, the unit is designed with a double filter facility that comes with two ISO Coarse 55% (G4) filters as standard with an optional ISO ePM1 60% (F7) pollen filter which provides additional protection against invisible, harmful particles creating an ultra-hygienic environment. ISO ePM Coarse 55% (G4) and ISO ePM1 60% (F7) can be used in conjunction with each other on supply air side.



TECHNICAL DATA

| Specification | DV65 Entro-V |
|--|--|
| Air flow m ³ /h / l/s @100Pa | 242 / 67.2 |
| For dwelling floor area up to (m ²) | 116 |
| Reference dwelling | 3 bed house |
| Thermal efficiency % | 84 - 88 |
| Heat exchanger | Counterflow (Plastic) |
| SEC class | A+ |
| Electrical supply | 230V / 1ph / 50Hz |
| Max power consumption (W) | 100 |
| Sound level @ 3m (dB(A)) | 32 - 43 |
| Specific Power Input (SPI) (W/(m ³ /h)) | 0.295 |
| Fans | EC |
| Electric heater (optional) (W) | 2 x 50 |
| IP classification | IP54 |
| Weight (kg) | 45 |
| Dimensions (L x D x H) (mm) | 580 x 430 x 690 |
| Controls | Digital controller |
| Duct diameter (mm) | 160 |
| Condensate discharge (mm) | 1/2 inch BSP |
| Summer Bypass damper | 100% Automatic |
| Frost protection | Yes |
| Filter class** | ISO Coarse 55% (G4), optional ISO ePM1 60% (F7) |
| Optional BMS Connectivity | Communication through I2C - Modbus |
| Casing | Galvanised steel. Powder paint. (20 mm insulation) |
| Mounting | Wall, Floor |
| Orientation of unit | Right or Left-handed |
| Part Number | 90001243 |

**Complies with ISO 16890

DIMENSIONS

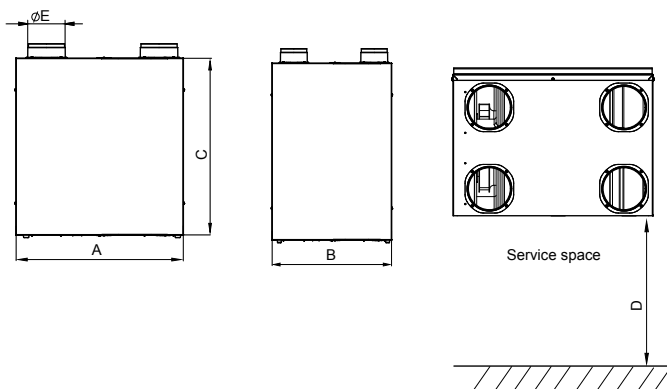

+ excludes motors. Motor warranty one year from date of purchase

| Model | A | B | C | D | E |
|-------|-----|-----|-----|-----|-----|
| DV65 | 580 | 430 | 690 | 400 | 160 |

PERFORMANCE

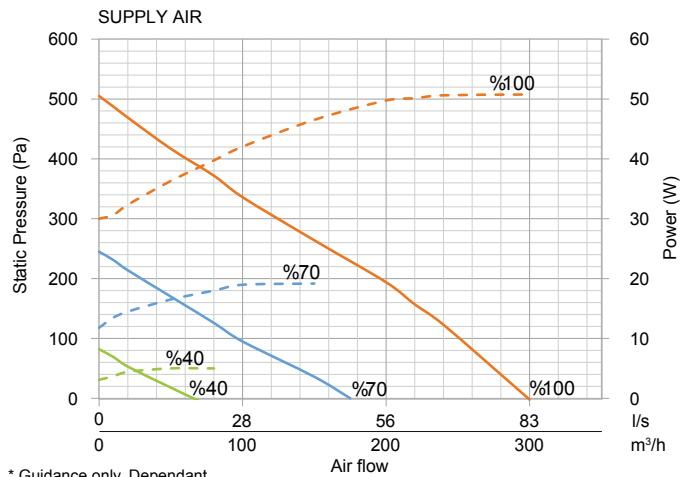

* Guidance only. Dependant upon system pressure.

SAP RESULTS

Systems with rigid ductwork only SAP 2005 results

| Exhaust terminal configuration | Specific Fan Power (W/l/s) | Thermal efficiency (%) |
|----------------------------------|----------------------------|------------------------|
| Kitchen + 1 additional wet room | 1.12 | 81 |
| Kitchen + 2 additional wet rooms | 1.02 | 81 |
| Kitchen + 3 additional wet rooms | 1.04 | 81 |
| Kitchen + 4 additional wet rooms | 1.14 | 81 |
| Kitchen + 5 additional wet rooms | 1.28 | 80 |

Systems with rigid ductwork only SAP 2012 results Thermal

| Exhaust terminal configuration | Specific Fan Power (W/l/s) | Thermal efficiency (%) |
|----------------------------------|----------------------------|------------------------|
| Kitchen + 1 additional wet room | 1.07 | 81 |
| Kitchen + 2 additional wet rooms | 1.12 | 81 |
| Kitchen + 3 additional wet rooms | 1.24 | 81 |

ACCESSORIES

The following options are available

| Accessory | Product Code |
|----------------------------------|--------------|
| Entro-V digital controller | 90001299 |
| Entro-V basic controller | 90001308 |
| DV65 Entro-V ISO Coarse 55% (G4) | 90001323 |
| DV65 Entro-V ISO ePM1 60% (F7) | 90001326 |
| DV65 Entro-V heater 0,5 kW | 90001335 |
| DV65 Entro-V heater 1 kW | 90001336 |
| DV65 Entro-V heaters 1,5 kW | 90001337 |
| DV65 Entro-V heater 2 kW | 90001341 |

ErP RATING

The DV65 Entro-V meets requirements set out by the Energy Related Products (ErP) Directive 2016, achieving an A+ rating. You can find out more about the ErP Directive and find the DV65 Fiche and Label at www.airflow.com Label 90001243

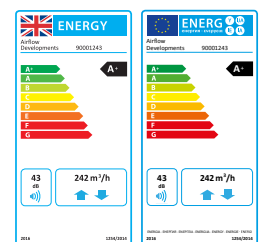

EntroV DV65

Mechanical Ventilation with Heat Recovery

UNIT CONFIGURATION

The unit is supplied as a right-handed version as standard.

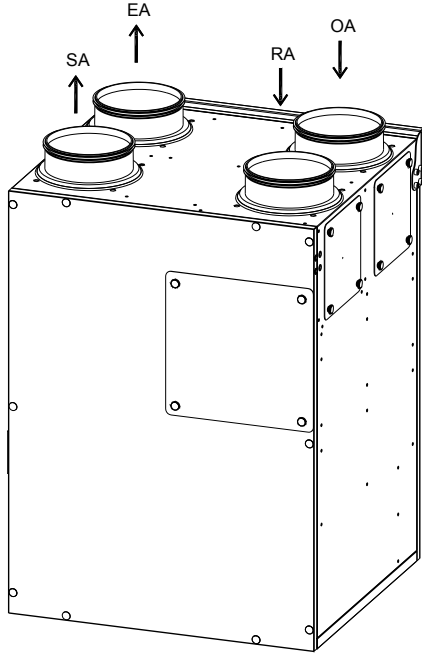

- OA** = Outside Air in
- SA** = Supply Air to habitable rooms
- RA** = Return Air from wet rooms
- EA** = Exhaust Air to outside

HEAT EXCHANGER DIAGRAM

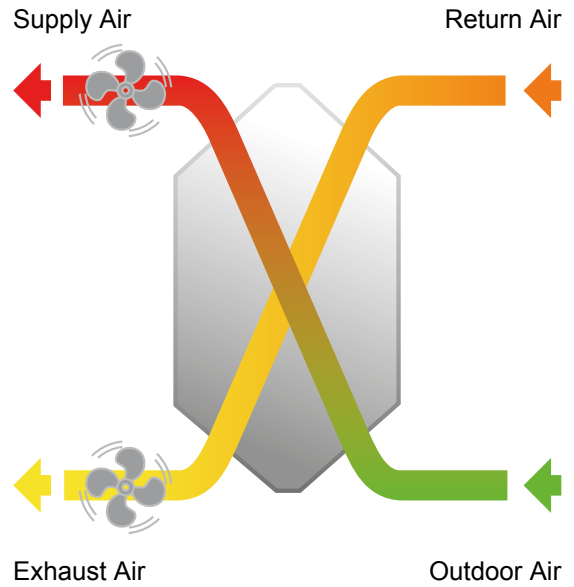

INSTALLATION

The units can be installed in vertical mounting positions, on the wall or on the floor. Hanging brackets, screws and feet are supplied with the unit. Also, the unit has interchangeability of spigots position from top to the sides.

CHANGING THE SPIGOTS POSITION

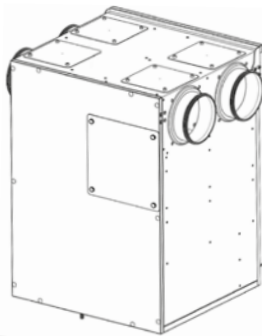
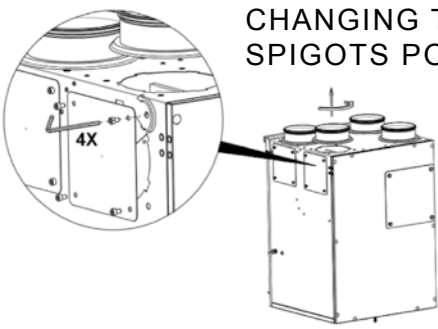

INSTALLATION ON THE WALL

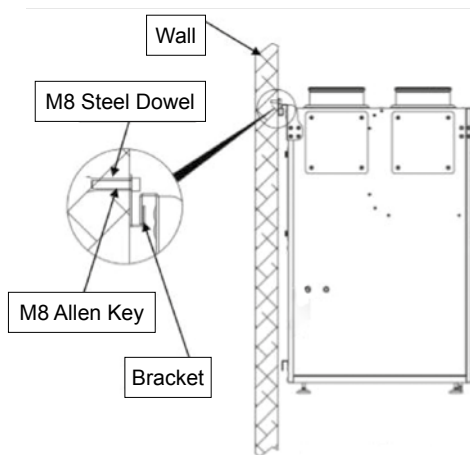

INSTALLATION ON THE FLOOR

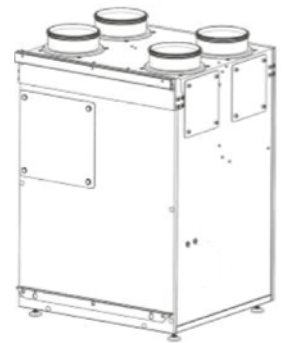

DIGITAL CONTROLLER USER INTERFACE

The controller has a user-friendly display to allow for commissioning and various features such as:

- User friendly and intuitive display symbols
- Independent fan speed control
- Screen brightness and contrast adjustments
- Weekly schedule set-up option
- Free cooling via the by-pass actuator
- Frost protection based on input signals from humidity and temperature sensors
- Boost function
- Faults indicator
- Filter reminder
- Fire alarm function
- Child-proof protection by locking the controller's keypad

This controller can only be used with DV65, DV82 and DV130 Entro-V ventilation units.

Equipment view

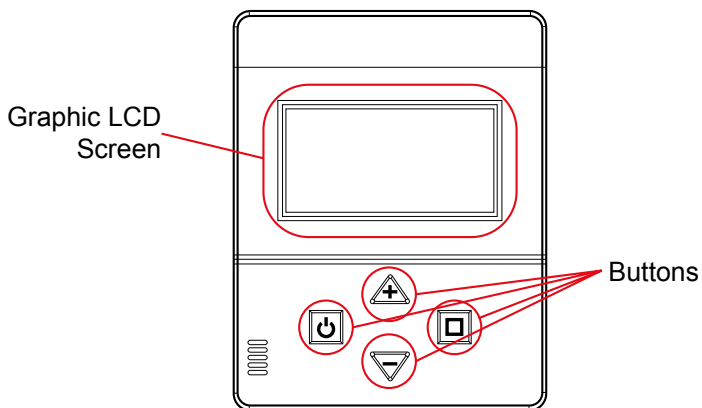

Dimensions

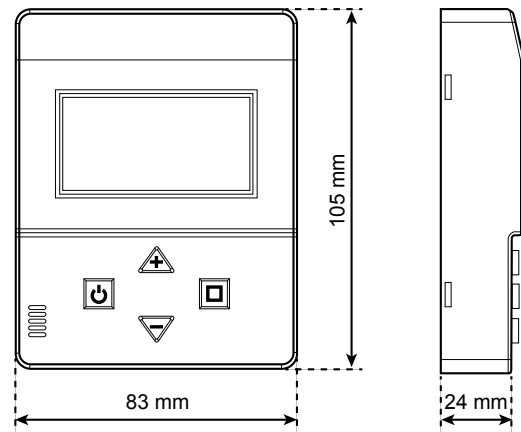

THE CONTENTS OF THE STANDARD KIT

One part number is all you need to quote



STANDARD KIT - PART No: 90001654

| Part no | Product Description | Quantity |
|----------|--|----------|
| 90001243 | DUPLEXVENT DV65 ENTRO-V | 1 |
| 90001299 | ENTRO-V DIGITAL CONTROLLER | 1 |
| 90000264 | 6-PORT IN LINE DIST FLAT BOX | 2 |
| 9041130 | 75 MM X 50 M ROUND AIRFLEXPRO COIL* | 2 |
| 9041132 | 75 MM CONNECTOR | 2 |
| 9041133 | 75 MM PIPE SEALING RING (PACK OF 10) | 4 |
| 51849404 | 150 MM / 6 IN ADJUSTABLE 60 - 325 MM CLAMP | 4 |
| 90000250 | 78 MM 90° CEILING/WALL PLENUM | 6 |
| 90000339 | 125 MM PLASTIC ADJUSTABLE SUPPLY VALVE | 3 |
| 90000340 | 125 MM PLASTIC ADJUSTABLE EXTRACT VALVE | 3 |
| 90000352 | AIRFLEXPRO ROUND CLIPS PK10 (RED)* | 3 |
| 90000470 | 160 MM TO 125 MM METAL PIPE CONNECTOR (MALE WITH SEAL TO FEMALE) | 2 |
| 90000506 | 160 MM STAINLESS STEEL ROUND COWL WITH MESH | 2 |
| 90000465 | 160 MM X 2 M ISO PIPE | 3 |
| 90000466 | 160 MM 45° ISO PIPE BEND | 2 |
| 90000467 | 160 MM 90° ISO PIPE BEND | 5 |
| 90000468 | 160 MM ISO PIPE CONNECTOR PLASTIC | 6 |

*The red round AirflexPro rolls can be supplemented by blue round AirflexPro rolls. *Red clips can also be supplemented by blue clips

OPTIONAL ACCESSORIES

| Part no | Product Description |
|----------|--|
| 90001379 | 75 MM X 50 M ROUND AIRFLEXPRO COIL (BLUE) |
| 90001381 | 75 MM AIRFLEXPRO FITTING CLIPS (BLUE) |
| 90000255 | 20 M COIL ELLIPTICAL AIRFLEXPRO DUCTING (RED) |
| 90000353 | 75 MM AIRFLEXPRO FITTING CLIPS (RED) |
| 90000499 | REGAL 160 MM COWL WITH FRONT APERTURE |
| 90000498 | REGAL 160 MM COWL WITH SIDE APERTURE |
| 90000126 | FIRE PROTECTION VALVE (EXTRACT) |
| 9041168 | METAL ADJUSTABLE AIR VALVE (SUPPLY) |
| 9041172 | METAL ADJUSTABLE AIR VALVE (EXTRACT) |
| 90000540 | ON/OFF SWITCH |
| 90000316 | 125 MM SQUARE SUPPLY/EXTRACT VALVE ADJUSTABLE, CLOSED FRONT WITH G2 FILTER |
| 90000251 | 90° VERTICAL TRANSITION PIECE (ROUND-ELLIPTICAL) |
| 90000252 | STRAIGHT TRANSITION PIECE (ROUND-ELLIPTICAL) |
| 90001326 | ISO EPM1 60% (F7) POLLEN FILTER |
| 90000259 | ELLIPTICAL SPIGOT CONNECTION |
| 90000249 | CEILING OR WALL PLENUM ELLIPTICAL |
| 9041177 | 160 X 1250 MM DUCT SOUND ATTENUATOR |
| 90000645 | 160 MM X 1 M SEMI FLEXIBLE INSULATED ATTENUATOR |
| 90000016 | INSULATION SEALING TAPE 50 M |

Entro[®]V DV65

Mechanical Ventilation with Heat Recovery

Entro-V DV65 Kit



Shrink wrap ready to be delivered

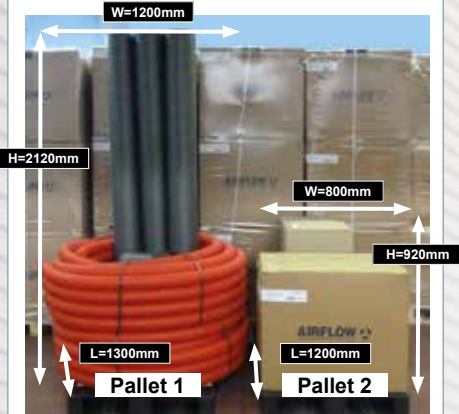

All components inside the red ducting coils

Entro -V DV65 Kit contents



Complete contents of Entro -V DV65 Kit ready to fit

| Dimensions (mm) | Pallet 1 | Pallet 2 |
|--|----------|----------|
| Height (includes the pallet height) (mm) | 2120 | 920 |
| Length (mm) | 1300 | 1200 |
| Width (mm) | 1200 | 800 |
| Weight of products (kg) | 34.5 | 76.35 |
| Weight of products + pallet (kg) | 41.3 | 83.15 |

Supply and extract air to and from rooms is done through anti-static smooth bore, hygienically lined AirflexPro ducting. Ensuring minimal in-duct airflow noise and dirt accumulation, it is supplied economically straight from the roll.

The durable, ribbed outer skin of AirflexPro offers excellent flexibility, strength and compressibility, up to 10 kN / m². These properties make it ideally suited for embedding straight into concrete screed without distortion, which ensures predicted airflow rates through ducts are maintained.

AIRFLEXPRO – MOVING AIR EFFICIENTLY AND EFFECTIVELY.

AirflexPro is an air ducting system, when used in conjunction with a Mechanical Heat Recovery Unit

(MVHR) it provides a total ventilation system for dwellings.

AirflexPro is a radial ducting system offering advantages over the more traditional branch systems. AirflexPro is suited to new build but can also be used in the retrofit market and can be combined with such technologies as coanda valves. The system has zero leakage and low system pressure, therefore making it a very efficient air movement system.



ZERO LEAKAGE SEMI RIGID DUCTING



Due to its flexible properties, the AirflexPro ducting can be installed easily and cost-effectively directly from the roll.

It has an anti-static and hygienic lining to help prevent dust and bacterial build up. When combining the install project cost with the components of a traditional branch duct system, AirflexPro with its quicker install and better quality components is better value for money.



AIRFLEXPRO = ENERGY SAVING

It makes no sense to invest in an energy efficient MVHR unit to improve well-being and indoor air quality when the energy saving benefits to be gained are lost through leakage from traditional branch ducting systems.

TRADITIONAL DUCTING = ENERGY LOSS

An efficient MVHR unit is only as good as its air distribution system. Traditional duct systems have numerous joints all of which are prone to leakage. Leaking duct systems are inefficient and waste energy, as a proportion of the air never reaches its destination.

Flexible and rigid branch systems can result in restricted airflows and higher system resistances. They can also transmit sound throughout the ducting causing unwanted and nuisance noise in other rooms.

Poor duct installation also costs money. Overcoming a leaky duct system means the MVHR unit will have to run at a higher speed to give the required airflow rates in the correct areas of the property. Badly designed duct systems, or systems that do not follow the designed route, will have higher system pressures. In extreme cases an MVHR unit sized correctly for a dwelling will not be able to cope with the extra demand created by the additional pressures. AirflexPro is a highly flexible, efficient and easy to install ducting system which eliminates these problems.

FEATURES

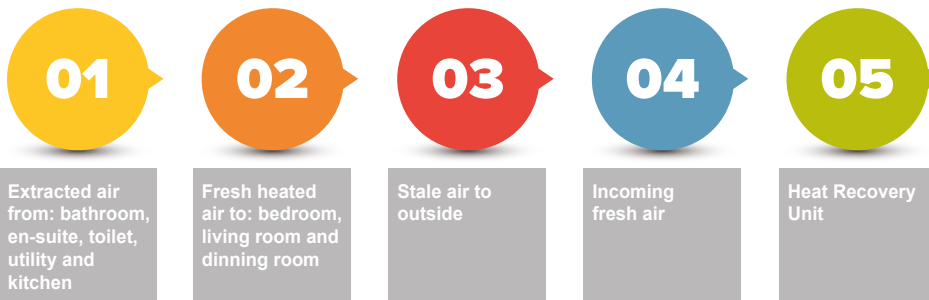

Adroit[®]

Smart Ventilation with Heat Recovery
Take control, at Home or “On the Go”



Alternative premium models to upgrade to

- Nine models
- Over 90% heat recovery
- Comes with 3 filters
- Integrated CO² sensor
- Integrated humidity sensor
- Internet enabled
- Passive House approved

CONTENTS INCLUDED IN KIT

Ceiling or Wall Plenum Round

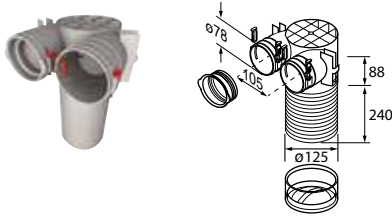

Part Number - 90000250

75 mm 90° Ceiling / Wall Plenum
Connects AirflexPro Round through the ceiling to the extract / supply valve. Can be cut down for varying height of void.

Straight Connection

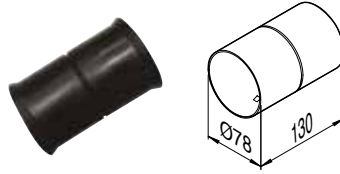

Part Number - 9041132

Connects AirflexPro round to AirflexPro round.

Sealing Rings Round



Part Number - 9041133

75 mm dia. AirflexPro
Round Sealing Ring (pack of 10).

Plastic Adjustable Air Valve (Supply)



Part Number - 90000339

ø125 mm Directional supply
Direct the airflow from this adjustable and lockable supply valve to any area in the room.

Round Cowl with Mesh

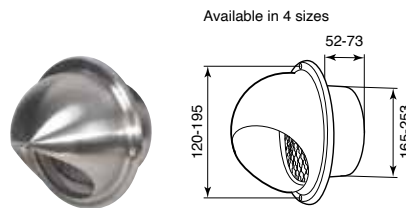

Part Number - 90000506

ø160 mm
A weather-resistant stainless steel round cowl with louvres suitable for air intake or discharge. To be used with a 160 mm diameter connection.

The cowl features a mesh / bird screen providing suitable protection against birds and pests and is very easy to install offering you a high-quality, no-hassle solution with an attractive finish.

KEY FEATURES:

Stainless steel construction for wall mounting.

Provides protection against pests.

Suitable for both supply and exhaust air.

6-Port In-Line Distribution Box (round)

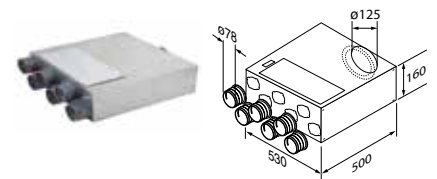

Part Number - 90000264

AirflexPro distribution boxes are the primary component in the quiet, effective distribution of supply and extract air, to and from the central MVHR unit. They can be configured for in-line, 90° angle, and side-on connection so that they integrate into any building layout enabling smooth easy access to connect to round and elliptical ducting. Available from 5 to 15 duct connection ports, depending on the system design and for full flexibility, it is supplied with fixing brackets and screws. They are fully insulated to retain warm air energy and acoustically lined to absorb airborne noise. Unused ports should be sealed with blanking caps. Constructed from durable steel they are tough for on-site handling and incorporate an access door enabling routine internal cleaning and maintenance. Each connection port has a keyway indicator mark to easily align round and elliptical duct connectors during the installation process.

Plastic Adjustable Air Valve (Extract)

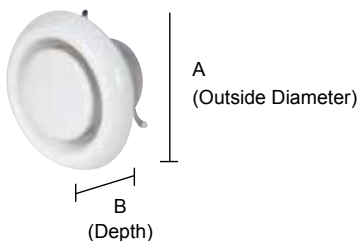

Part Number - 90000340

ø125 mm (A 165 x B 65 mm)
White plastic lockable extract valve.

ISO Pipe (Internal Connection)

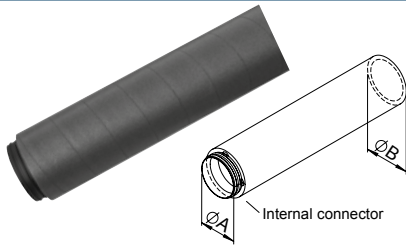

Part Number - 90000465

ø160 x 2000 mm - A 160 mm B 192 mm

Comes with internal plastic connector.

Pre-insulated one-piece

Quick and easy assembly

Tough, durable, anti-static EPP

Fire retardant to B2

Avoids condensation build-up

Sound-absorbing, smooth bore pipe

Choice of components to suit any layout

SPECIFICATIONS

Thickness: 15 mm

Material density: 60g/dm³, antistatic

Thermal conductivity: 0.042 W / mK

Application range: -25 °C to +80 °

Elasticity: 30% DIN 52612

ISO 90° Degree Elbow

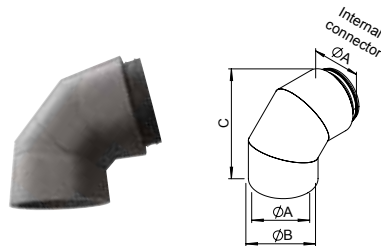

Part Number - 90000467

ø160 mm - A 160 mm B 192 mm C 272 mm

Comes with internal plastic connector.

See specifications of part number - 90000465

ISO 45° Degree Elbow

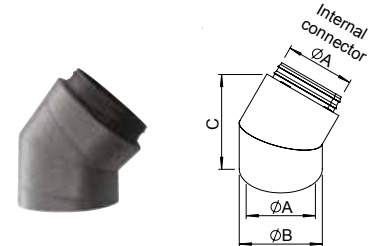

Part Number - 90000466

ø160 mm - A 160 mm B 192 mm C 242 mm

Comes with internal plastic connector.

See specifications of part number - 90000465

ISO Pipe

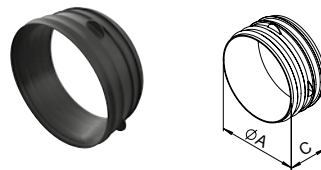

Part Number - 90000468

ø160 mm - A 160 mm C 80 mm

Internal plastic connector for ISO pipes.

Metal Reducer Connector with Airtight Seal

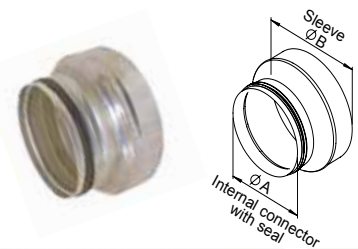

Part Number - 90000470

A ø125 mm (M) (GSK) to B ø160 mm (F) (Male with seal to Female)

Key: (M) Male, (F) Female (GSK) Gasket with seal.

Worm Drive Clip



Part Number - 51849404

ø150 mm/ 6" adjustable
60 mm - 325 mm 8 mm wide

AirflexPro ducting - for air distribution system



Product Number - 9041130

AirflexPro round



Product Number - 90000352

AirflexPro duct clips

Digital controller



Part Number - 90001299

Digital controller for quick and easy commissioning

OPTIONAL ACCESSORIES

AirflexPro ducting - for air distribution system (blue)



Product Number - 90001379
AirflexPro round



Product Number - 90001381
AirflexPro duct clips

AirflexPro Elliptical ducting - for air distribution system



Product Number - 90000255
20 m coil (elliptical) 51 mm x 115 mm



Product Number - 90000353
AirflexPro elliptical duct clips

Regal Front Entry Cowl



Part Number - 90000499
To suit ø160 mm ISO duct
A 265 mm D 97 mm C 240 mm

Regal Side Entry Cowl

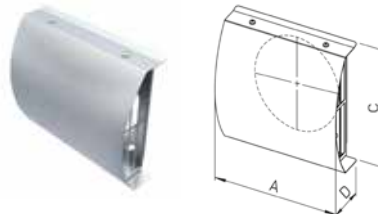

Part Number - 90000498
To suit ø160 mm ISO duct
A 265 mm D 97 mm C 240 mm

Fire Protection Valve (Extract)



Part Number - 90000126
ø125 mm
White powder coated, metal, lockable valve with thermal fuse safety feature.

Metal Adjustable Air Valve (Supply)



Part Number - 9041168
ø125 mm
White powder coated lockable supply valve.

Metal Adjustable Air Valve (Extract)



Part Number - 9041172
ø125 mm
White powder coated lockable extract valve.

Stylish Supply / Extract Valve

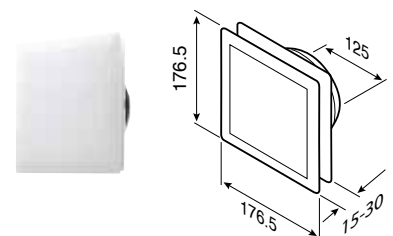

Part number - 90000316
ø125 mm Square supply / extract adjustable valve with filter.

OPTIONAL ACCESSORIES

On / off Switch



Part Number - 90000540

Single pole

90° Vertical Transition Piece

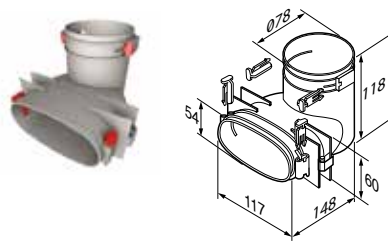

Part Number - 90000251

90° Vertical Transition Piece
(round-elliptical)

Straight Connection Piece

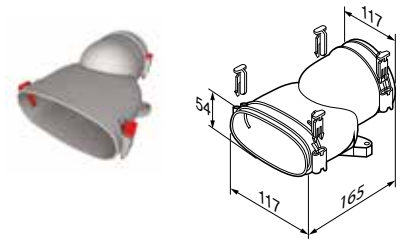

Part Number - 90000252

Straight Transition Piece
(round-elliptical)

F7 Pollen Filter



Part Number - 90001326

ISO ePM1 60% (F7) pollen filter
Additional filter to reduce the ingress of pollen into the home. Used in conjunction with existing filter.

Elliptical Spigot Connection

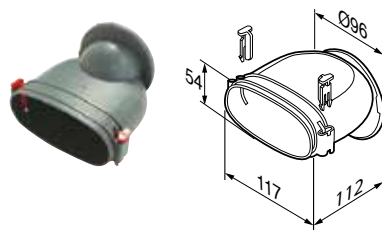

Part Number - 90000259

Elliptical Spigots for
Distribution Boxes

Ceiling or Wall Plenum Elliptical

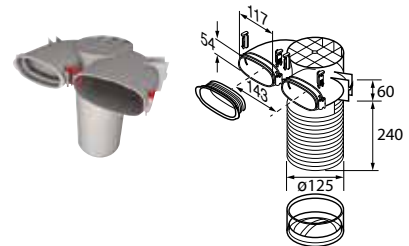

Part Number - 90000249

54 x 117 mm 90°
Ceiling / Wall Plenum

Duct Sound Attenuator

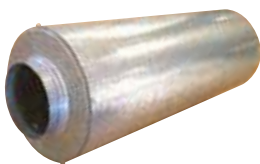

Part Number - 9041177

ø160 x 1250 mm

Complete with air tight seals. Made from durable galvanised steel.

Semi-flexible Insulated Attenuator



Part Number - 90000645

ø160 x 1 m length

Helps reduce noise ingress.
Helps connect two miss aligned ducts.
Insulated to reduce energy loss.

Insulation Sealing tape



Part Number - 90000016

50 mm width x 50 m length

Aluminium tape for use with various insulation materials.



Choosing Entro-V MVHR unit means you are investing in the quality of your indoor air and your family's health and well-being.

Entro-V will help you create a home to nurture and grow your family in an environment they can thrive in.

The Entro-V unit will deliver many years of high quality performance and service for you and your home.



FIELD SUPPORT



At Airflow we do not view any of our customers a short term agreement. We believe that by working together in partnership we can achieve better results in realising our shared objectives to deliver efficient, effective and reliable ventilation solutions.

Our knowledgeable, trained technicians can provide support to ensure your ventilation project runs smoothly and where issues arise, they can advise on the most suitable course of action to provide a successful outcome.

Airflow offers full field support across the UK and are supported by an internal technical team offering help and support for any issues or queries.



CONTACT US



Airflow Developments Limited

Tel: 01494 525252
e-mail: info@airflow.com

Customer Services

Tel: 01494 560800
e-mail: customer_services@airflow.com

Technical Support

Tel: 01494 560950
e-mail: technical_support@airflow.com







Airflow Developments Limited

Aidelle House, Lancaster Road,
Cressex Business Park,
High Wycombe, Buckinghamshire,
United Kingdom, HP12 3QP
Registered company 550374
airflow.com

Also Available Through



Connect With Us!

-  [AirflowD](#)
-  [AirflowDevelopments1](#)
-  [AirflowD](#)
-  [airflowdevelopmentsltd](#)
-  [Airflow Developments](#)
-  [Airflow Developments](#)



UNITED KINGDOM (head office)

Airflow Developments Limited
Aidelle House, Lancaster Road
Cressex Business Park
High Wycombe, Bucks. HP12 3QP.

Tel: +44 (0) 1494 525252
Email: info@airflow.com
Web: airflow.com

GERMANY

Airflow Lufttechnik GmbH
Postfach 1208
D-53349
Rheinbach, Germany

Tel: +49 (0) 2226 92050
Email: info@airflow.de
Web: airflow.de

CZECH REPUBLIC

Airflow Lufttechnik - Praha
Hostynska 520
10800 Praha 10
Prague, Czech Republic

Tel: +42 (0) 2747 72230
Email: info@airflow.cz
Web: airflow.cz